

DSI

EPOXY CAST IRON DRAINAGE PIPE SYSTEM EN877

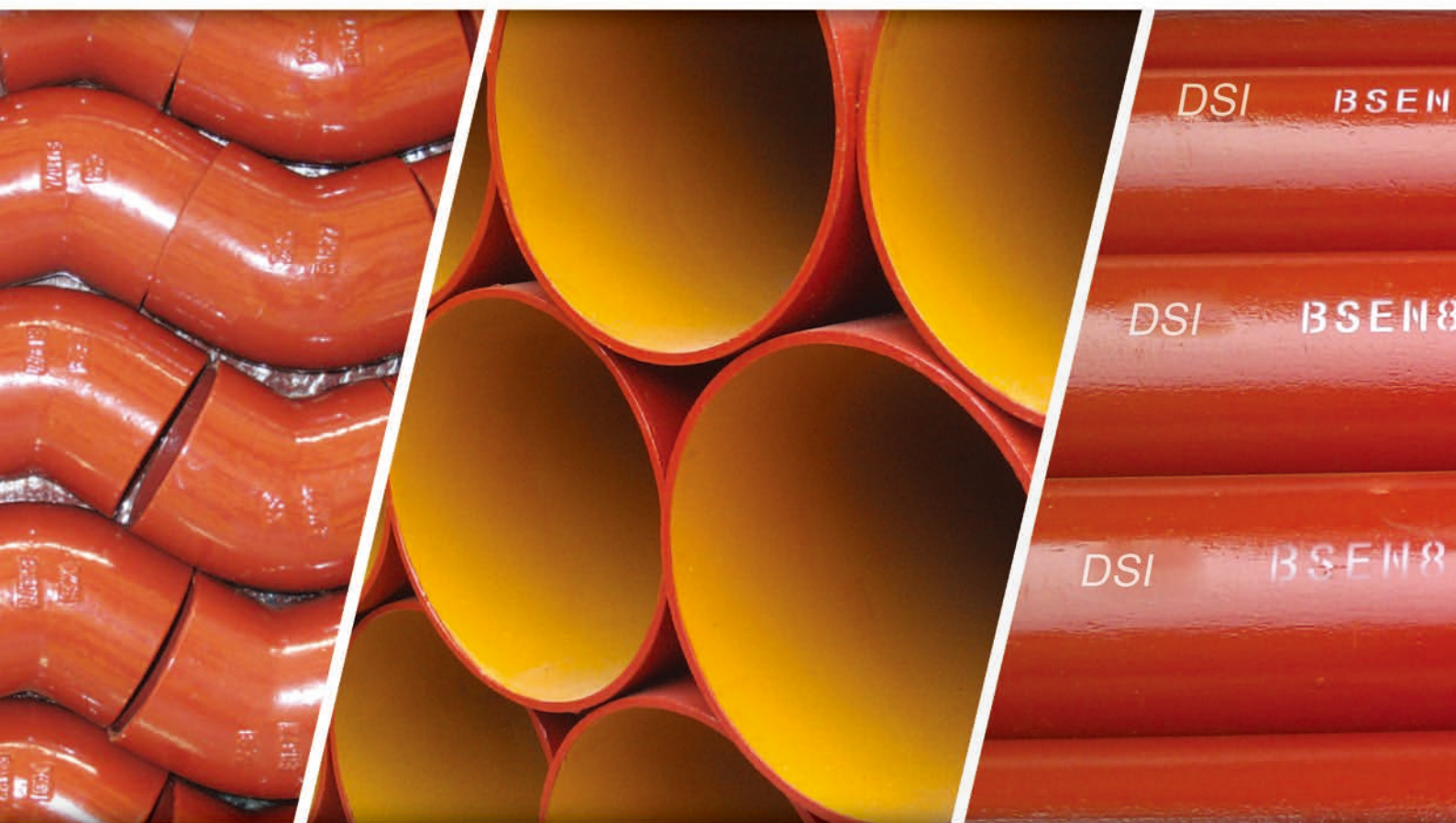

DSI

EPOXY CAST IRON DRAINAGE PIPE SYSTEM EN877

Introduction

Made from 100% recyclable materials, DSI epoxy cast iron pipe systems are not only environmental friendly, but also satisfy many properties necessary to withstand the aggressive conditions both internal and external of the pipes and fittings; these properties include its excellent resistance to abrasion, corrosion, impact and fire. DSI also has low noise transmission compared to common uPVC drainage pipe systems. DSI is designed as long lasting building materials. It had customers appalled with the ease and speed of installation.

引言

由100%可循環再用物料製造的DSI紅坭系列不但環保，並且管道內外均具備抵受外來環境侵害的特性包括：高度防磨損、抗銹蝕、耐撞擊、防火。相較於一般的uPVC塑膠去水系統，DSI紅坭更具有低噪音的性能。DSI紅坭是一種耐用的去水管道，其安裝便捷的優點，深受用家歡迎。

Standard

DSI epoxy cast iron pipe systems with nominal size between 40-300mm comply with BSEN877. BSEN877 guarantees the quality of the materials, dimensions and tolerances, mechanical properties (like water pressure, tensile strength and brinell hardness) appearance, and standard coatings for the epoxy cast iron pipes, fittings and couplings.

產品規格

DSI紅坭系列的尺寸由40mm至300mm，均符合BSEN877標準，保證其品質——用料、尺寸、機械性能（如水壓、拉力、硬度）外表及保護層——達到理想標準。

Strength

Iron is well known for its strength and abrasion resistance. The shape and impact strength of DSI products are unchanged under exposure of sunlight and weathering, while uPVC and PVC pipes would soften, deform and become brittle under intense temperature change.

高強度

鐵的強度高、能抗磨損是人所共知的，縱使在風雨日曬下，DSI紅坭的形狀及撞擊強度不會因而改變或減弱；相反，uPVC及PVC塑膠去水喉會受溫差的影響而變軟、變形及變脆。

Quiet

DSI's sturdy and dense properties reduce pipe vibration creating a silent drainage system. Studies had proven iron is the quietest material out of all other common drainage pipe materials. Due to KAM's naturally silent characteristics, no complicated and costly sound insulation is needed.

低噪音

DSI紅坭結實而高密度的特性可減少喉管的震動，形成安靜的管道系統。鐵已被證實為眾多去水物料中最安靜的材料。由於KAM紅坭低噪音的特性，可以免除繁複而昂貴的隔音裝置。

Non-Toxic and Non-Combustible

No toxic gas will be emitted from DSI in the event of a fire. Iron is also non-combustible so DSI epoxy cast iron pipes and fittings are recoverable after a fire.

無毒及不易燃

火警發生時，DSI紅坭不會釋放有毒氣體。由於鐵是一種不易燃的物料，DSI紅坭及配件在火警後可以重用。

DSI

EPOXY CAST IRON DRAINAGE PIPE SYSTEM EN877

Anti-Corrosive

All DSI epoxy cast iron pipes and fittings are internally and externally finished with corrosive resistant epoxy coating to prevent fouling and corrosion. The epoxy coating on DSI epoxy cast iron pipes and fittings provides an excellent exterior under humid and tropical conditions. With the increasing use of domestic chemicals, such as organic acids and caustic soda, the epoxy interior is the perfect solution to handle the corrosive substances. The epoxy coating also provides a smooth path for solid waste creating a block-free interior. Around the world, epoxy cast iron pipes are widely used in laboratories, hospitals, factories and homes because of its corrosive resistant property.

抗銹蝕

DSI紅坭及配件的內外層均塗上防銹的環氧樹脂以防結垢及防銹蝕。在潮濕多雨的熱帶環境下，DSI紅坭外層的環氧樹脂塗層為管道提供良好的保護。在家用化學劑如有機酸、苛性鈉等的用量日漸增多下，環氧樹脂塗層是對抗侵蝕物質的最佳屏障，同時亦造成了一個平滑的管道來防止污物阻塞。紅坭具有抗腐蝕的特性，令其廣泛應用於世界各地之實驗室、醫院、工廠及住宅等。

Couplings

Lightweight couplings are specially engineered to guarantee a strong, quick and easy connection between DSI pipes and fittings. Made from stainless steel with rubber gaskets, the couplings match the pipe and fittings' non-corrosive properties.

喉箍

精密設計的喉箍可以穩固、快捷及容易地接駁DSI紅坭，而且極之輕身。配合紅坭喉管及管件抗銹蝕的特性，紅坭箍採用的材料為不銹鋼及橡膠墊圈。

Assembly Instructions 安裝指引



1. 將喉箍的膠圈套在管端外，至膠圈深度的一半
Fit the rubber gasket on the outer rim of the pipe until it is half way into the gasket.
2. 將上半段的膠圈外翻
Roll back the upper half of the rubber gasket outwards.
3. 放另一段的喉管或配件套入膠圈內，再翻回膠圈
Place the connecting pipe or fitting into the rubber gasket and fold back the gasket.
4. 套上不銹鋼喉箍及將螺絲收緊
Wrap the stainless steel coupling around the rubber gasket and alternately tighten bolts.



DSI

EPOXY CAST IRON DRAINAGE PIPE SYSTEM EN877

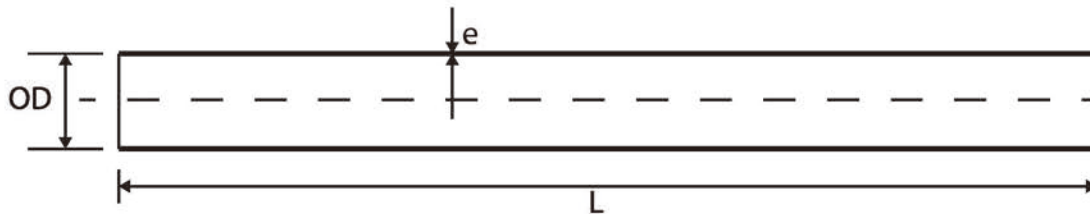

Nominal Size 公稱直徑	Outside Diameter 外徑		Wall Thickness 壁厚		Length 長度	Weight 重量
DN	OD	Tolerance公差	e	Tolerance公差	L	
mm	mm	mm	mm	mm	mm	kg
40	48	+ 2 / - 1	3.0	- 0.5	3000 ± 20	9.4
50	58		3.5	- 0.5		13.0
75	83		3.5	- 0.5		19.0
100	110		3.5	- 0.5		25.2
150	160	+ 2 / - 1	4.0	- 0.5		42.2
200	210	+ 2.5 / - 2.5	5.0	- 1.0		69.6
250	274		5.5	- 1.0		99.8
300	325		6.0	- 1.0		130.0

DSI

EPOXY CAST IRON DRAINAGE PIPE SYSTEM EN877

88° Bend 短邊

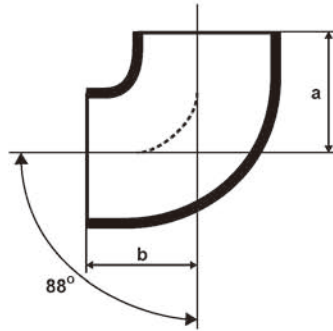

Nominal Size 公稱直徑 DN	a	b	weight 重量 kg
mm	mm	mm	kg
40	70	70	0.5
50	75	75	0.7
75	95	95	1.4
100	110	110	2.1
150	145	145	4.9
200	175	175	8.8
250	230	230	17.9
300	260	260	28.0

45° Bend 短邊

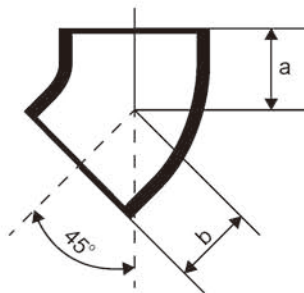

Nominal Size 公稱直徑 DN	a	b	weight 重量 kg
mm	mm	mm	kg
50	50	50	0.5
75	60	60	1.0
100	70	70	1.6
150	90	90	3.5
200	110	110	6.2
250	130	130	10.3
300	155	155	17.3

88° Bend with Access Door 多口短邊

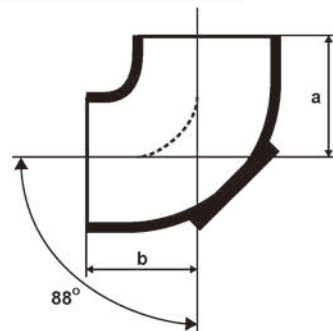

Nominal Size 公稱直徑 DN	a	b	weight 重量 kg
mm	mm	mm	kg
75	84	84	3.0
100	110	110	3.4
150	145	145	7.0

45° Bend with Access Door 多口短邊

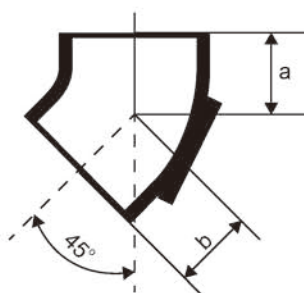

Nominal Size 公稱直徑 DN	a	b	weight 重量 kg
mm	mm	mm	kg
100	70	70	2.6
150	90	90	6.5

DSI

EPOXY CAST IRON DRAINAGE PIPE SYSTEM EN877

Vent Bend 預仔邊

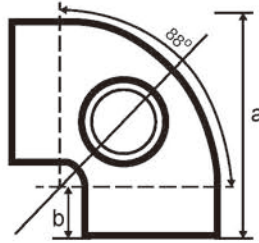

Nominal Size 公稱直徑 DN	a	b	weight 重量 kg
mm	mm	mm	kg
100X50	168	50	3.4

Top Bend 企頭邊

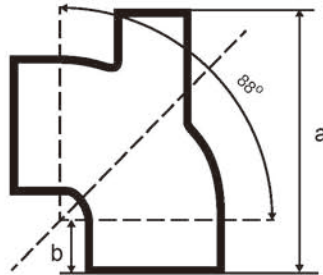
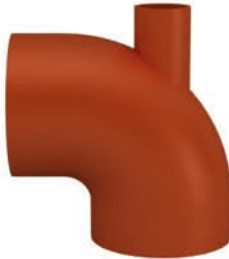

Nominal Size 公稱直徑 DN	a	b	weight 重量 kg
mm	mm	mm	kg
100X50	200	42	3.4

88° Large Radius Bend 大彎邊

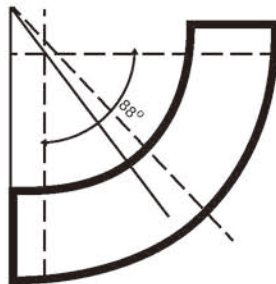

Nominal Size 公稱直徑 DN	a	b	weight 重量 kg
mm	mm	mm	kg
100	230	230	5.4
150	245	245	9.8

88° Large Radius Bend with Access Door 多口大彎邊

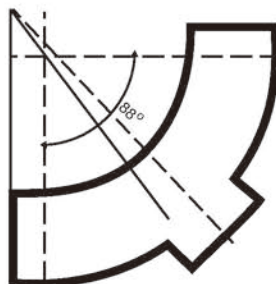

Nominal Size 公稱直徑 DN	a	b	weight 重量 kg
mm	mm	mm	kg
100	230	230	6.1

DSI

EPOXY CAST IRON DRAINAGE PIPE SYSTEM EN877

88° Single Branch 三叉

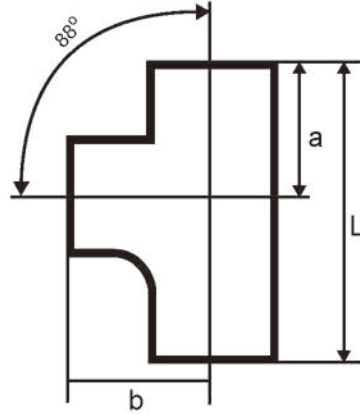
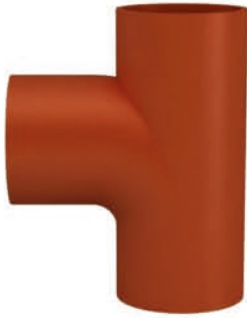

Nominal Size 公稱直徑 DN	L	a	b	weight 重量 kg
mm	mm	mm	mm	kg
40 X 40	140	70	70	0.8
50 X 50	145	68	80	0.9
75 X 50	155	75	90	1.6
75 X 75	180	83	95	1.9
100 X 50	170	76	105	2.1
100 X 75	190	88	110	2.5
100 X 100	220	105	115	2.9
150 X 50	200	100	140	3.7
150 X 75	215	100	140	4.0
150 X 100	245	115	145	5.2
150 X 150	300	142	155	6.9
200 X 100	270	126	175	8.0
200 X 150	325	152	185	10.8
200 X 200	360	184	180	12.8
250 X 250	450	230	225	19.8

45° Single Branch 斜叉

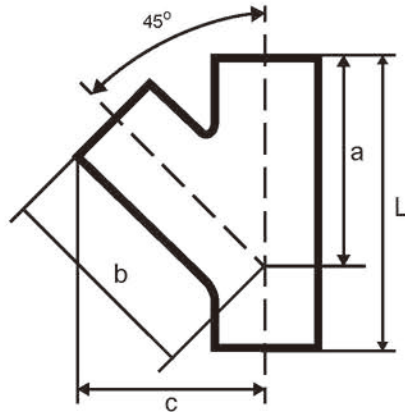

Nominal Size 公稱直徑 DN	L	a	b	c	weight 重量 kg
mm	mm	mm	mm	mm	kg
50 X 50	160	115	115	102	1.4
75 X 50	180	135	135	116	1.8
75 X 75	215	155	155	139	2.4
100 X 50	180	150	150	135	2.5
100 X 75	220	170	170	150	3.1
100 X 100	260	190	190	174	4.2
150 X 75	235	205	205	170	5.9
150 X 100	280	225	225	198	6.8
150 X 150	355	265	265	244	9.2

88° Single Branch with Access Door 多口三叉

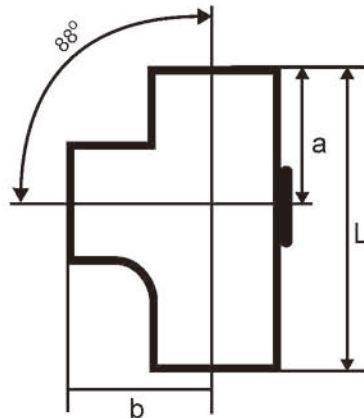

Nominal Size 公稱直徑 DN	L	a	b	weight 重量 kg
mm	mm	mm	mm	kg
75 X 75	180	83	95	2.5
100 X 50	170	76	105	3.0
100 X 100	220	105	115	4.5
150 X 100	245	115	145	7.5
150 X 150	300	142	155	8.2

DSI

EPOXY CAST IRON DRAINAGE PIPE SYSTEM EN877

88° Double Branch 十字叉

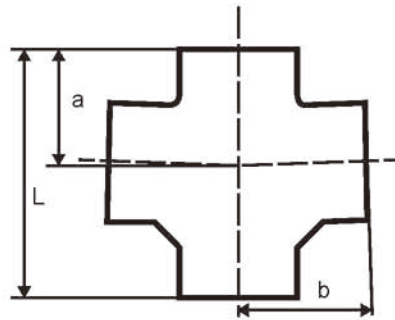
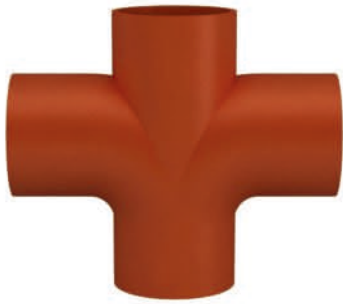

Nominal Size 公稱直徑 DN	L	a	b	weight 重量 kg
100 X 50	170	76	105	2.2
100 X 100	220	105	115	3.2
150 X 100	245	115	145	7.1

88° Corner Double Branch 曲尺叉

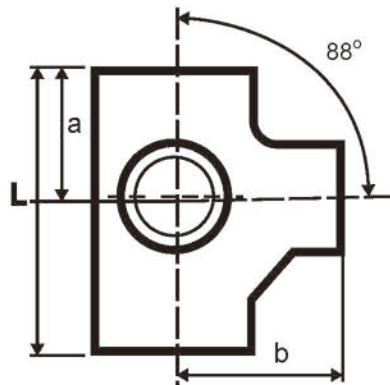

Nominal Size 公稱直徑 DN	L	a	b	weight 重量 kg
100 X 100 X 100	220	105	115	3.4

Short Pipe with Access Door 多口短坭

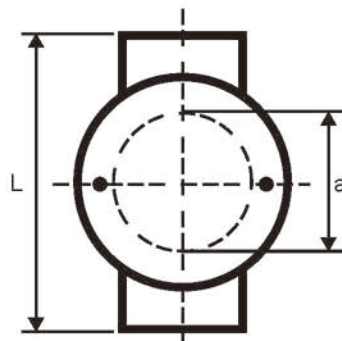

Nominal Size 公稱直徑 DN	a	b	weight 重量 kg
100	250	100	5.5
150	300	100	11.5

DSI

EPOXY CAST IRON DRAINAGE PIPE SYSTEM EN877

Reducer 刁士

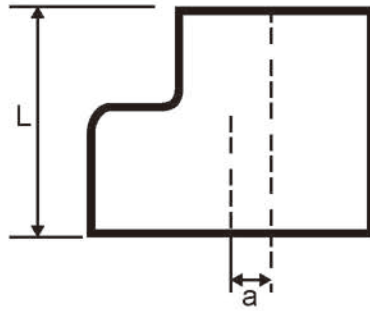

Nominal Size 公稱直徑 DN	a	b	weight 重量 kg
75 X 50	75	10	0.7
100 X 50	80	25	0.9
100 X 75	85	16	1.1
150 X 75	100	41	2.1
150 X 100	105	25	2.2
200 X 100	115	50	4.1
200 X 150	125	25	4.3

Cap 喉帽

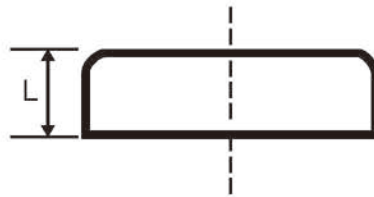

Nominal Size 公稱直徑 DN	L	weight 重量 kg
50	30	0.2
75	35	0.5
100	40	0.8
150	50	1.7

P-Trap 淺水格氣

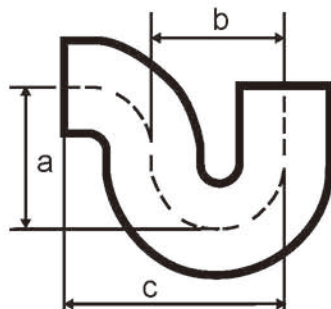

Nominal Size 公稱直徑 DN	a	b	c	weight 重量 kg
50	101	102	191	2.2
75	140	146	230	5.0
100	165	178	267	6.9

DSI

EPOXY CAST IRON DRAINAGE PIPE SYSTEM EN877

Anti-Syphon Trap 防吸力格氣

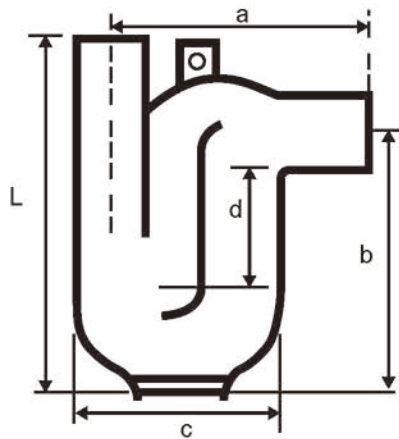

Nominal Size 公稱直徑							weight 重量
DN	L	a	b	c	d	kg	
50	250	122	182	110	60	3.7	
75	300	177	205	160	60	9.1	
100	392	215	282	230	100	16.8	

Deep water seal P-Trap 深水格氣

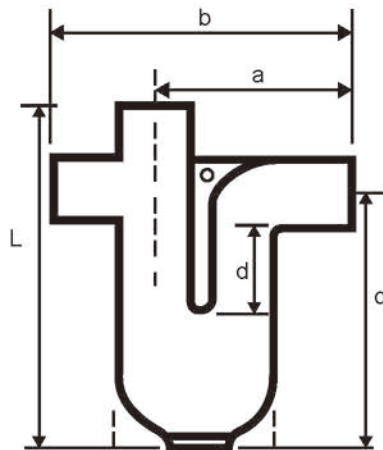

Nominal Size 公稱直徑							weight 重量
DN	L	a	b	c	d	kg	
50	250	122	190	182	60	2.8	
75	293	172	265	200	60	5.8	
100	392	215	325	282	100	8.5	
150	493	325	470	348	100	19.5	

DSI

EPOXY CAST IRON DRAINAGE PIPE SYSTEM EN877

Type 'B' Stainless Steel Coupling (SS 304 / SS316) 不銹鋼喉箍

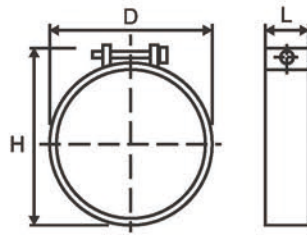

Nominal Size
公稱直徑

DN	D	H	L
mm	mm	mm	mm
50	70	83	41
70	92	105	45
100	122	135	45
150	173	186	54
200	232	246	66

Type 'E' Stainless Steel Coupling (SS 304 / SS316) 不銹鋼喉箍

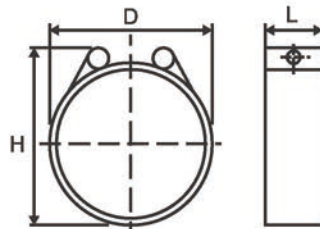

Nominal Size
公稱直徑

DN	D	H	L
mm	mm	mm	mm
50	67	85	50
75	92	110	55
100	117	135	55
150	168	186	78

Type 'CH' Stainless Steel Coupling (SS 304 / SS316) 不銹鋼喉箍

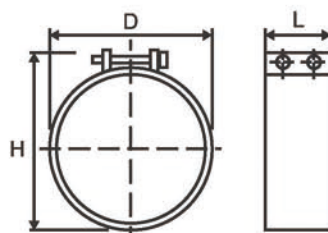

Nominal Size
公稱直徑

DN	D	H	L
mm	mm	mm	mm
40	62	76	56.5
50	72	86	56.5
75	97	111	56.5
100	124	138	56.5
150	174	188	70.5
200	226	256	82
250	290	318	140
300	342	370	140